

V1 ( 1 : 16 )  
INSIDE VIEW

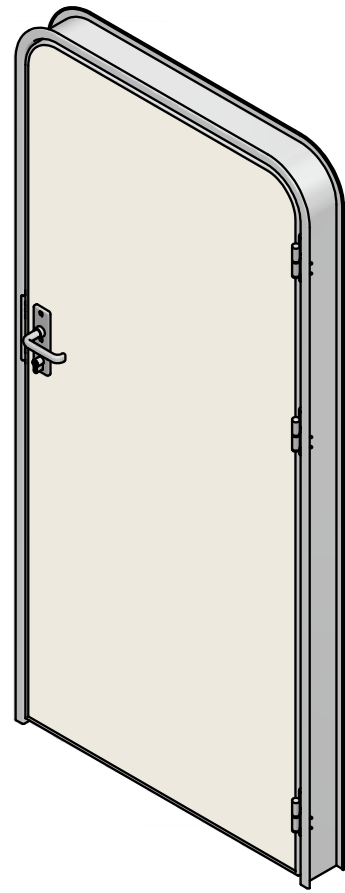

V2 ( 1 : 16 )  
OUTSIDE VIEW

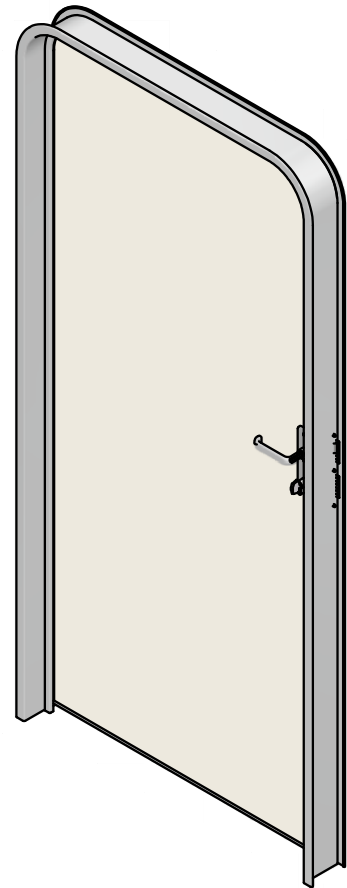

V3 ( 1 : 16 )

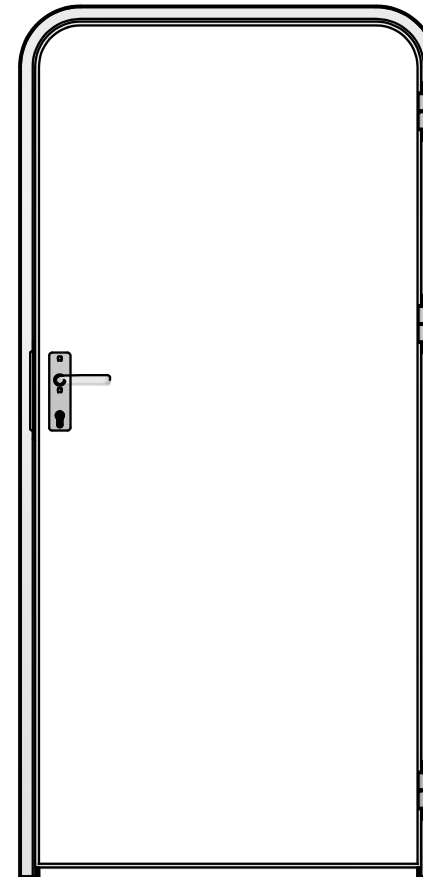

V4 ( 1 : 16 )

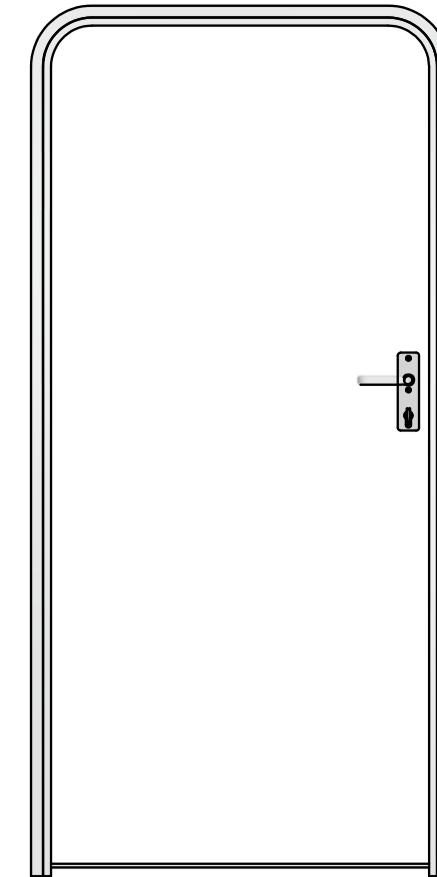

| REVISION HISTORY  |             |   |                          |
|---|-------------|---|--------------------------|
| REV   | DESCRIPTION | DATE  | APPROVED                 |
| A   | Released    | 27.02.2020  | RP                       |
| <b>LIBRA ACCOMODATION DOOR TYPE AC 32 - 2R</b>  |             |   |                          |
| Date<br>27.02.2020  | Checked by  | Scale<br>True scaling<br>in A3 format                         | Customer<br><b>LIBRA</b> |
| Designed by<br>RP   | Approved by | Date  |                          |
|  LIBRA-PLAST AS<br>N-6060 HAREID, Norway<br>Tel.: +47 70 09 54 00<br>Fax: +47 70 09 54 01<br>E-Mail: office@libra.no |             | Issue<br>A  | Sheet<br>1 / 2           |
|   |             | Drawing no.<br>LX-3-01493<br>Project no.<br><b>LX-3-01493</b> |                          |

Note: 1 STEP FILE:  
Libra\_AC 32 -2R-800x1800-RH

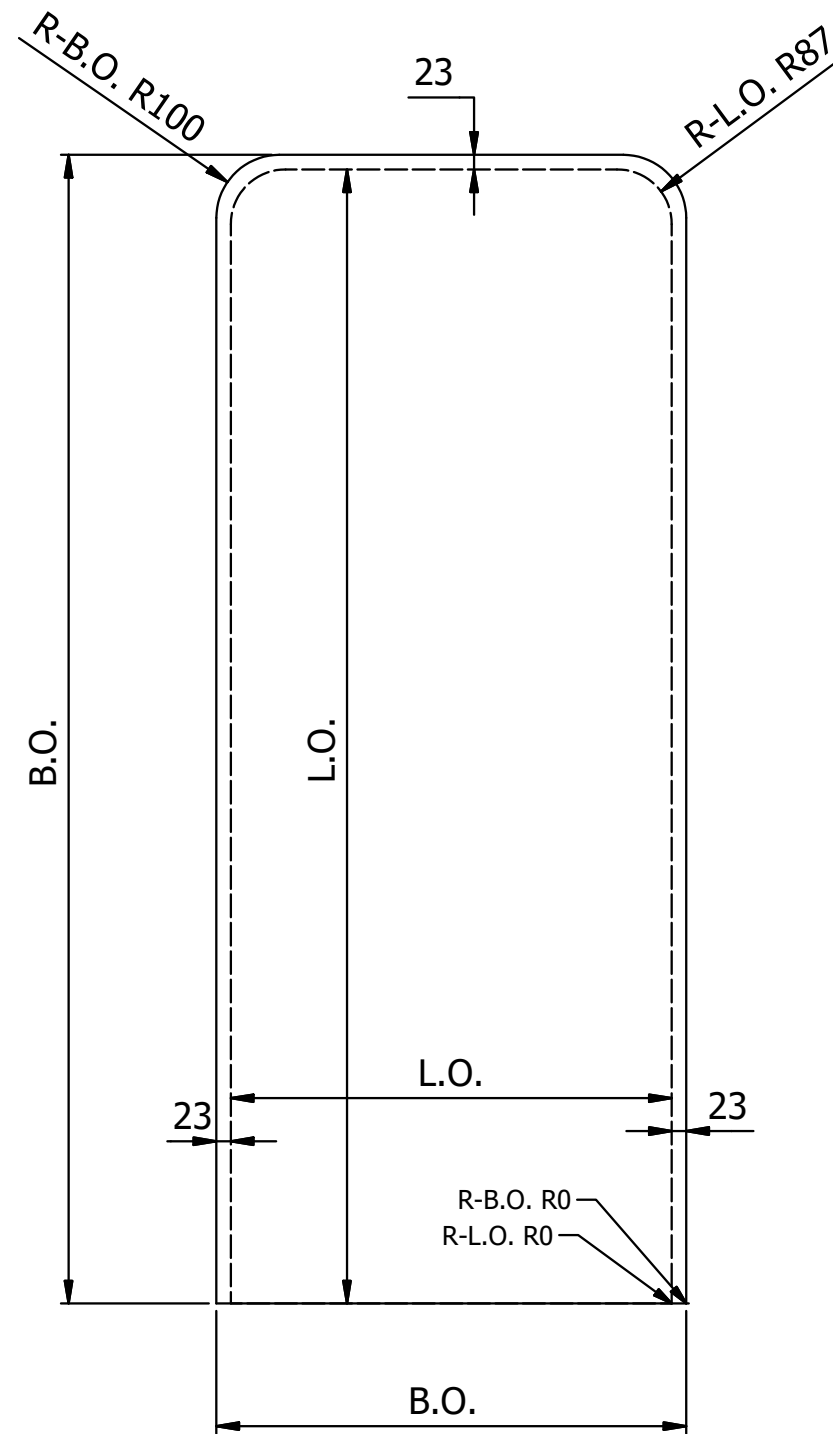
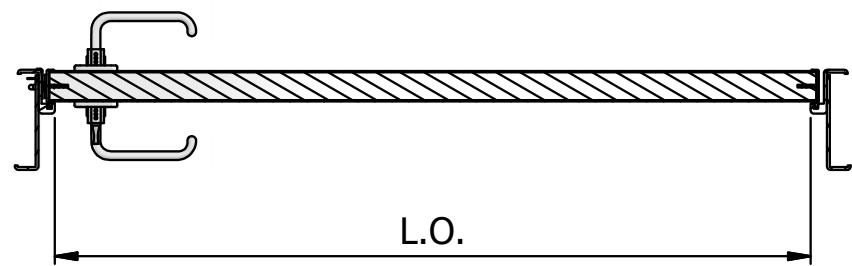
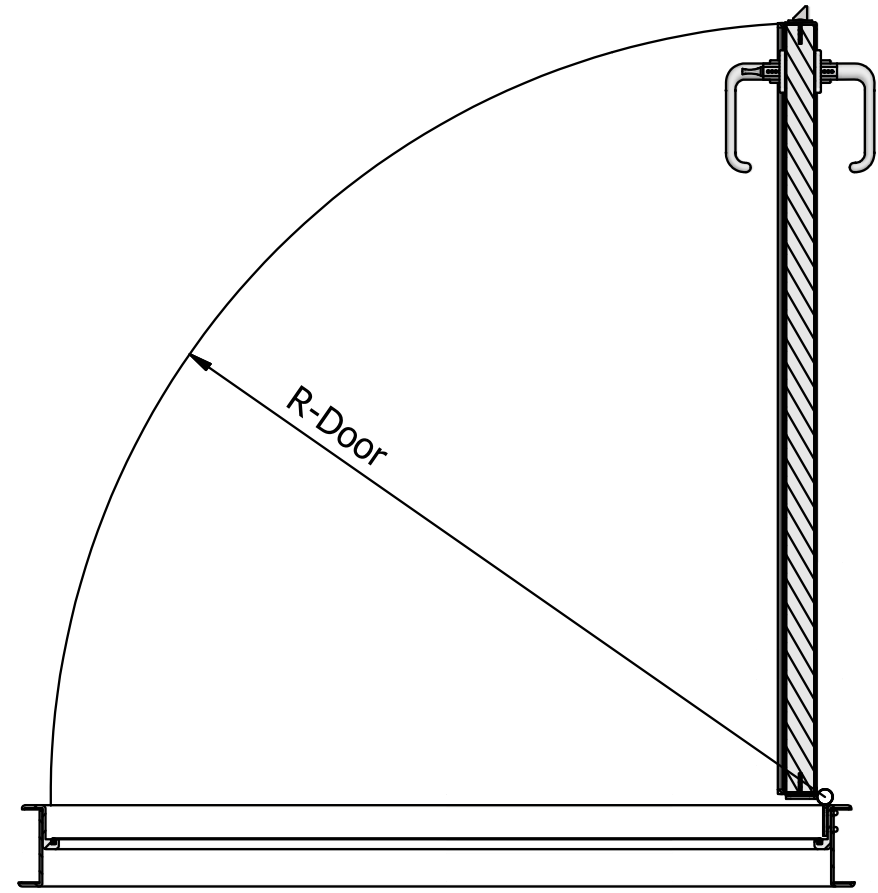

**LIBRA ACCOMODATION DOOR TYPE AC 32 - 2R**

|   |             |                                       |   |
|---|-------------|---------------------------------------|---|
| Date<br>27.02.2020  | Checked by  | Scale<br>True scaling<br>in A3 format | Customer<br><b>LIBRA</b>                    |
| Designed by<br>RP   | Approved by | Date                                  | Issue<br>A                                  |
|  LIBRA-PLAST AS<br>N-6060 HAREID, Norway<br>Tel.: +47 70 09 54 00<br>Fax: +47 70 09 54 01<br>E-Mail: office@libra.no |             |                                       | Drawing no.<br>LX-3-01493<br>Sheet<br>2 / 2 |
|   |             |                                       | Project no.<br><b>LX-3-01493</b>            |