

V1 (1 : 16)
INSIDE VIEW

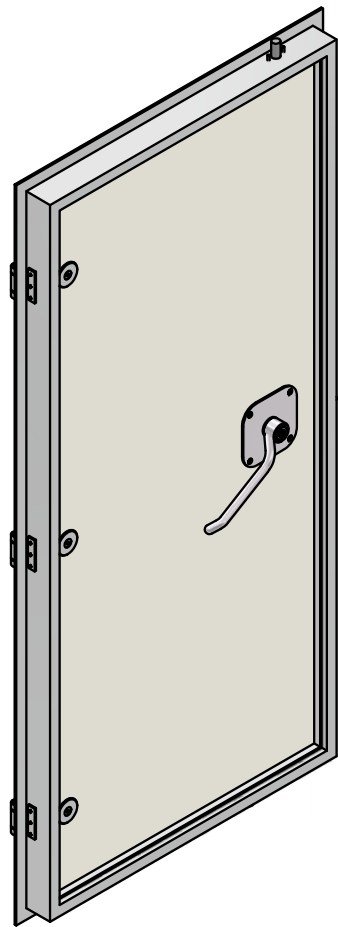

V2 (1 : 16)
OUTSIDE VIEW

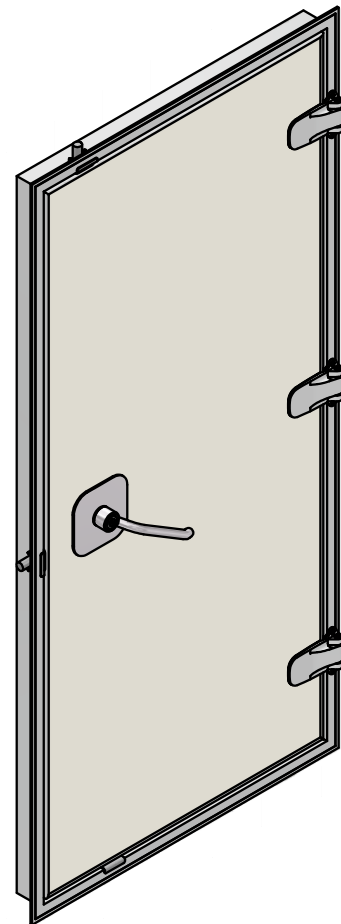

V3 (1 : 16)

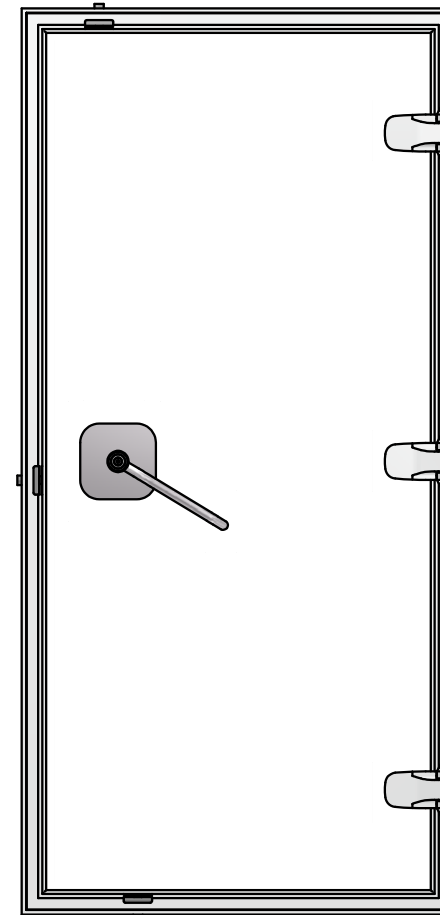

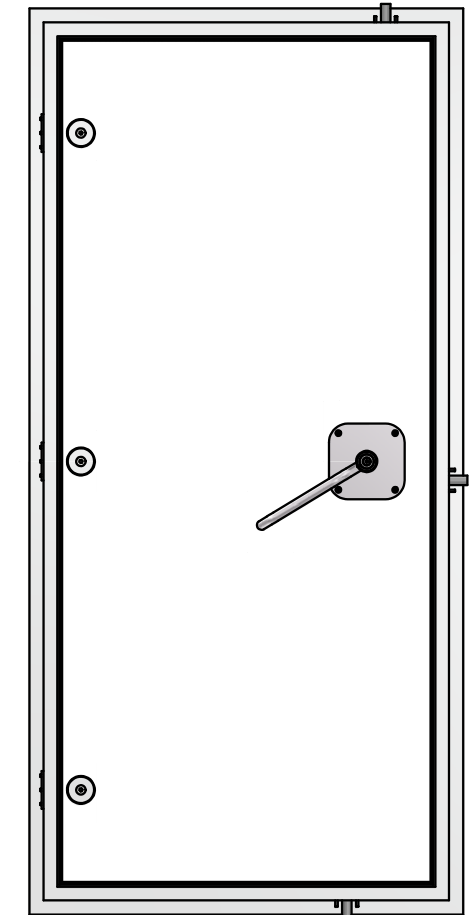

V4 (1 : 16)

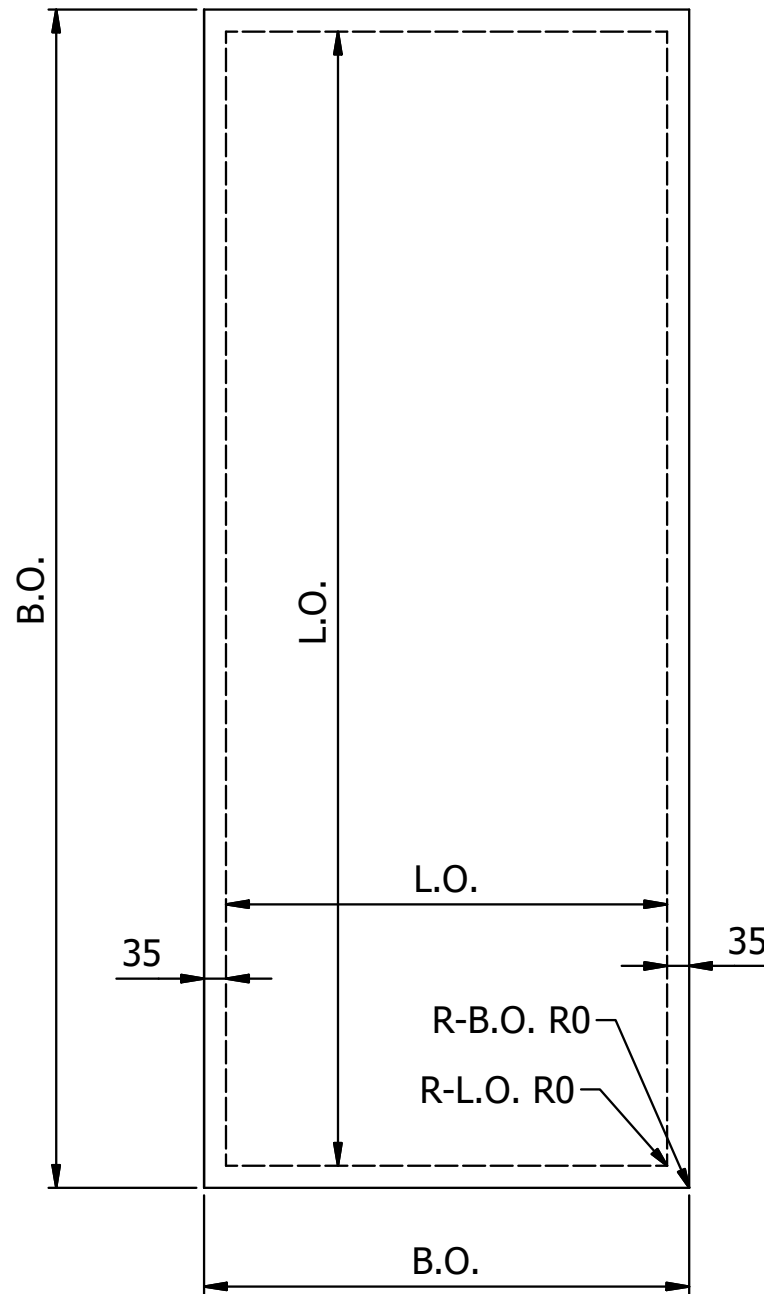
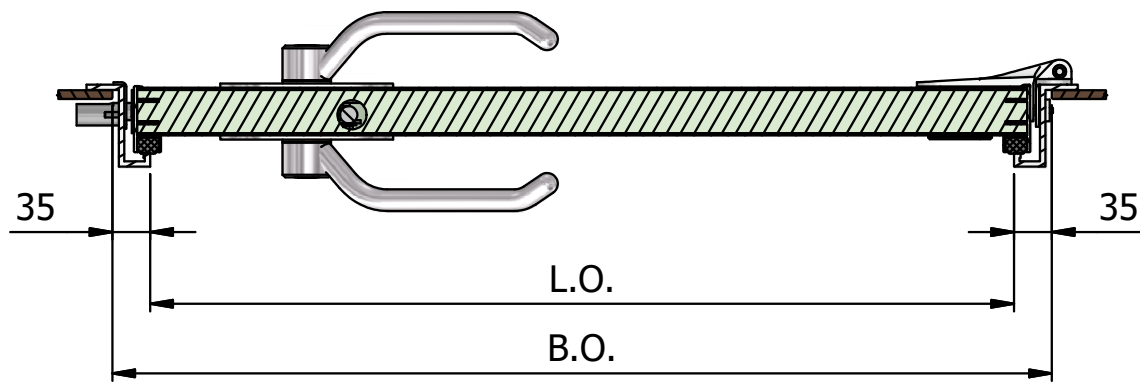
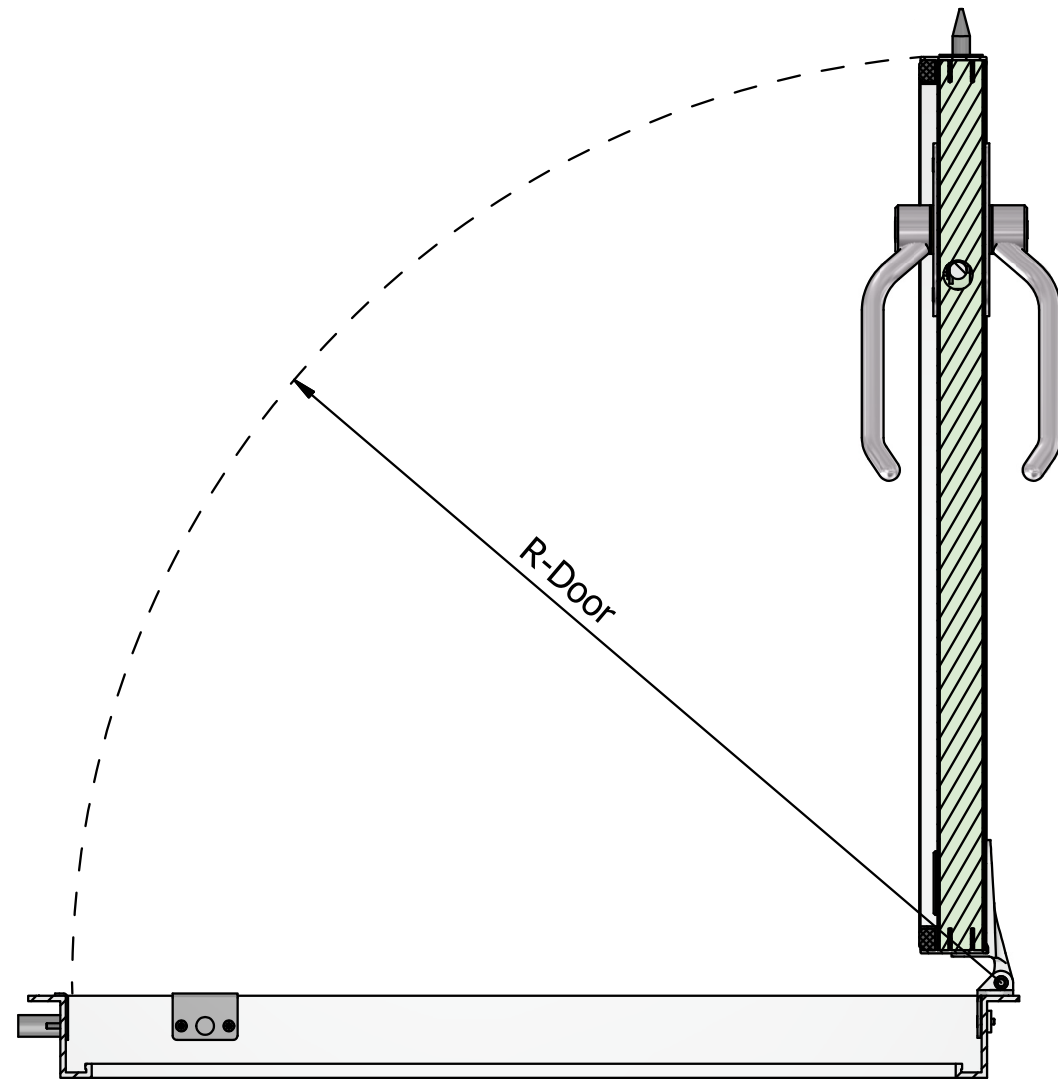

| REVISION HISTORY | | | |
|---|-------------|---|--------------------------|
| REV | DESCRIPTION | DATE | APPROVED |
| A | Released | 25.02.2020 | MA |
| LIBRA SPRAYTIGHT COMPOSITE GRP DOORS TYPE HSC.C | | | |
| Date 25.02.2020 | Checked by | Scale True scaling in A3 format | Customer LIBRA |
| Designed by MA | Approved by | Date | |
|  LIBRA-PLAST AS N-6060 HAREID, Norway Tel.: +47 70 09 54 00 Fax: +47 70 09 54 01 E-Mail: office@libra.no | | Issue A | Sheet 1 / 2 |
| | | Drawing no. LX-3-01472 Project no. LX-3-01481 | |

Note: 1 STEP FILE:
Libra_HSC-C-QA-Z-SPR-800x1800-RH



| | | | | | |
|---|-------------|---------------------------------------|---------------------------|----------------|----------------------------------|
| LIBRA SPRAYTIGHT COMPOSITE GRP DOORS TYPE HSC.C | | | | | |
| Date 25.02.2020 | Checked by | Scale True scaling in A3 format | Customer LIBRA | | |
| Designed by MA | Approved by | Date | Issue A | | |
|  LIBRA-PLAST AS N-6060 HAREID, Norway Tel.: +47 70 09 54 00 Fax: +47 70 09 54 01 E-Mail: office@libra.no | | | Drawing no. LX-3-01472 | Sheet 2 / 2 | Project no. LX-3-01481 |