

V1 (1 : 16)
INSIDE VIEW

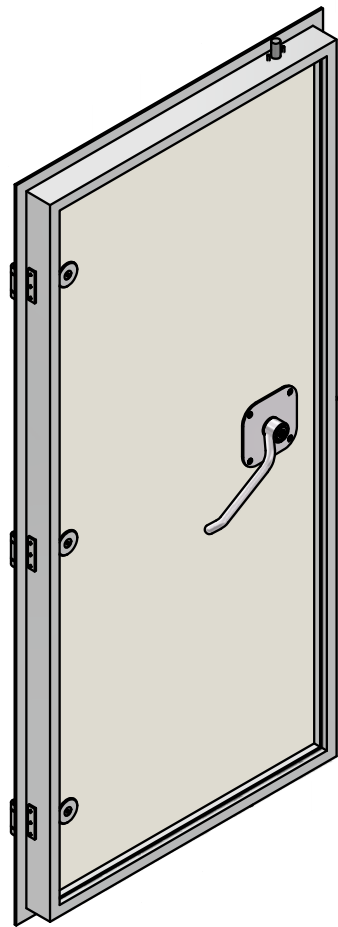

V2 (1 : 16)
OUTSIDE VIEW

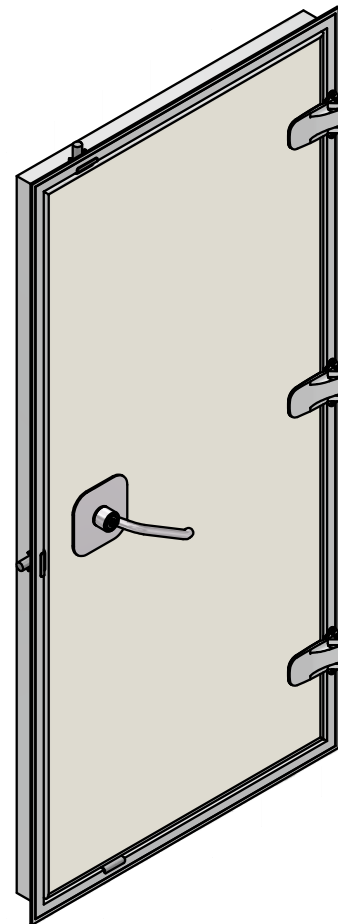

V3 (1 : 16)

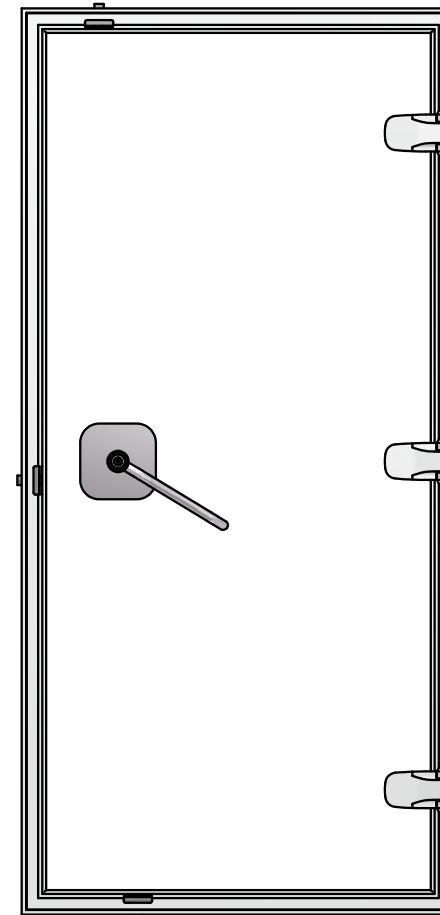

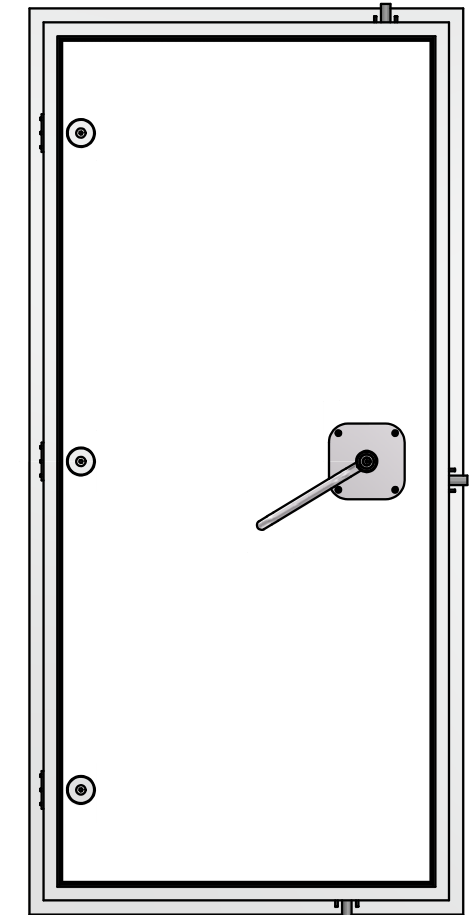

V4 (1 : 16)

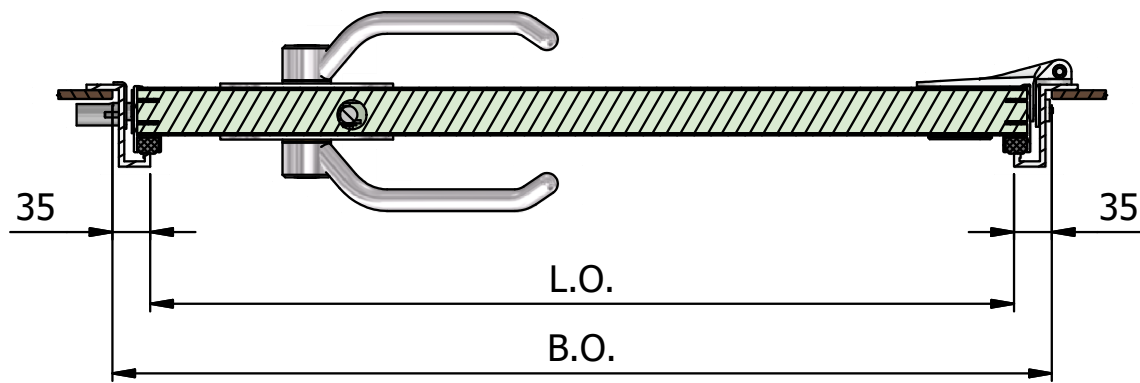
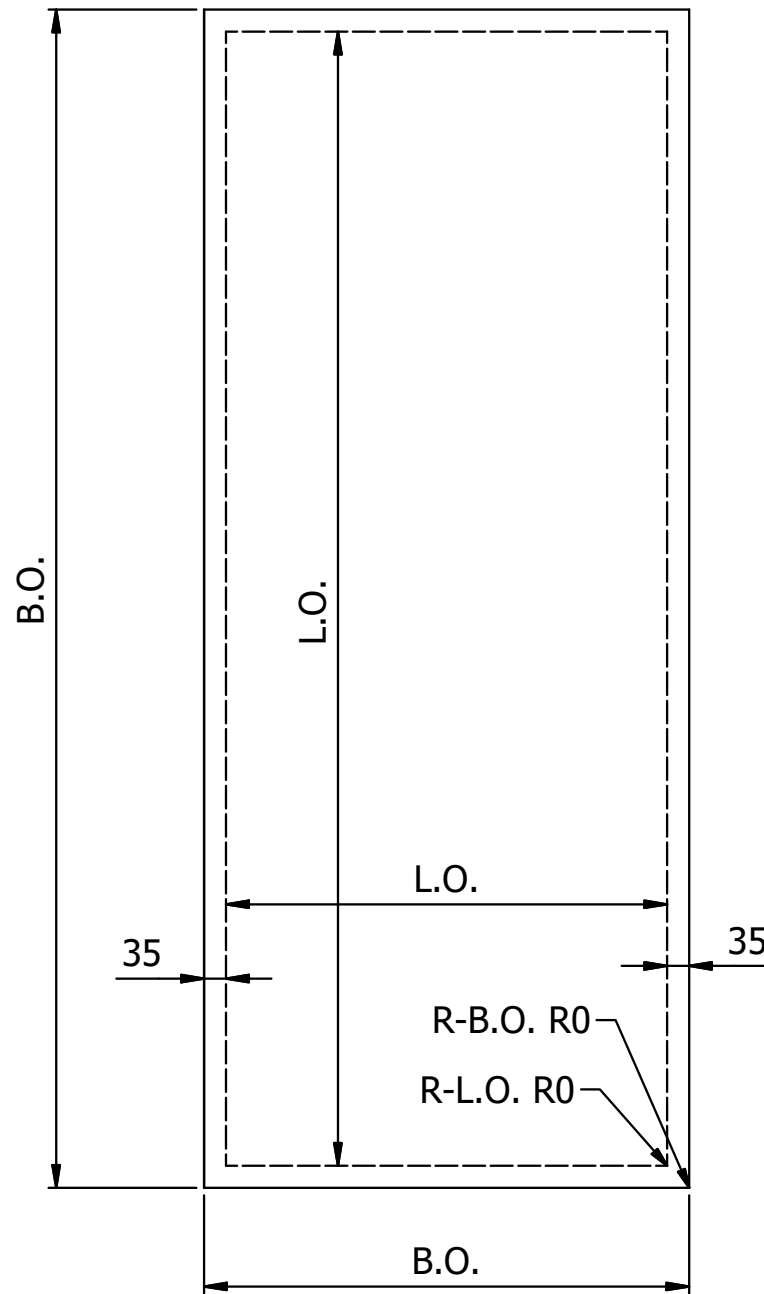
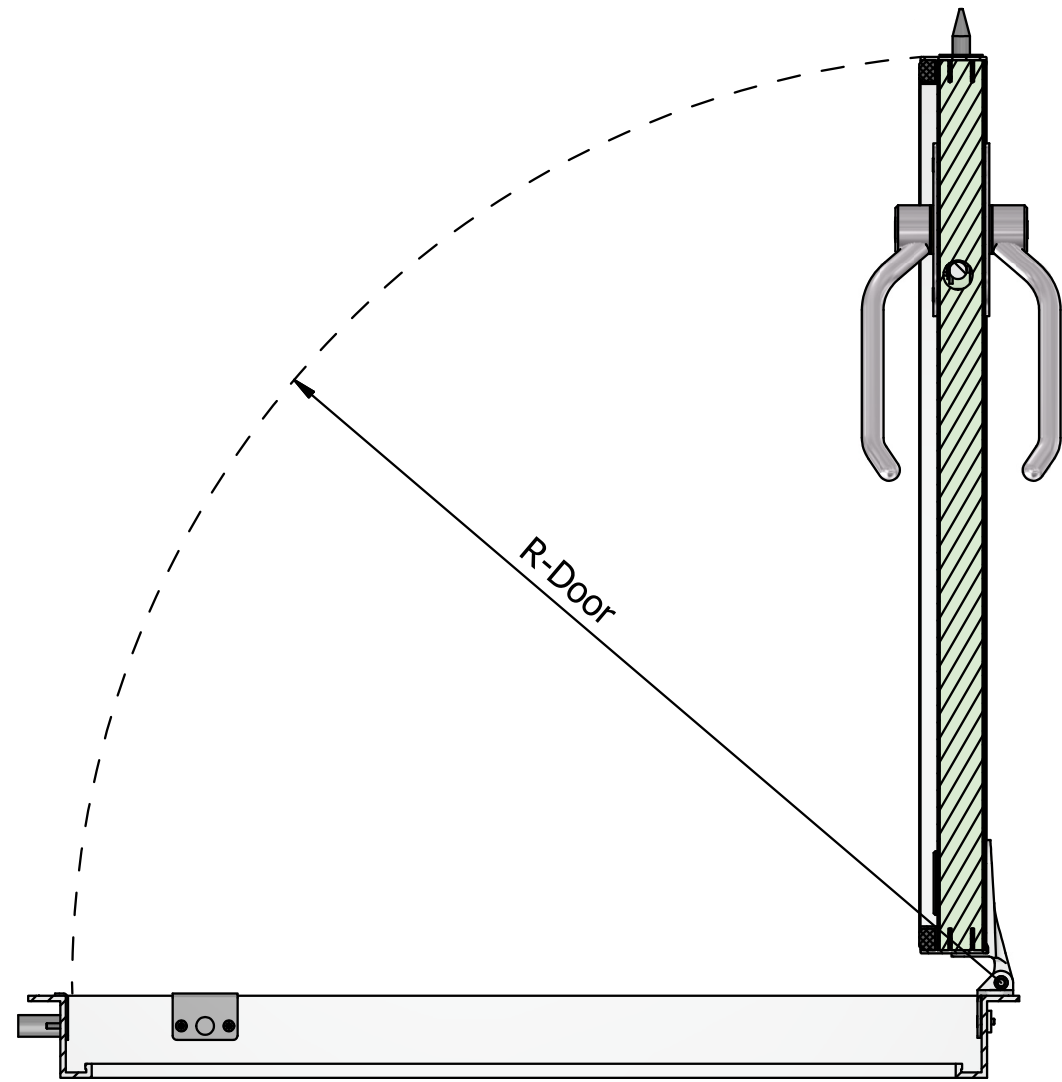

REVISION HISTORY			
REV	DESCRIPTION	DATE	APPROVED
A	Released	24.02.2020	MA
LIBRA WEATHERTIGHT COMPOSITE GRP DOORS TYPE HSC.C			
Date 24.02.2020	Checked by	Scale True scaling in A3 format	Customer LIBRA
Designed by MA	Approved by	Date	
 LIBRA-PLAST AS N-6060 HAREID, Norway Tel.: +47 70 09 54 00 Fax: +47 70 09 54 01 E-Mail: office@libra.no		Issue A	Sheet 1 / 2
		Drawing no. LX-3-01472 Project no. LX-3-01472	

Note: 1 STEP FILE:
Libra_HSC-C-QA-Z-800x1800-RH



LIBRA WEATHERTIGHT COMPOSITE GRP DOORS TYPE HSC.C					
Date 24.02.2020	Checked by	Scale True scaling in A3 format	Customer LIBRA		
Designed by MA	Approved by	Date	Issue A		
 LIBRA-PLAST AS N-6060 HAREID, Norway Tel.: +47 70 09 54 00 Fax: +47 70 09 54 01 E-Mail: office@libra.no			Drawing no. LX-3-01472	Sheet 2 / 2	Project no. LX-3-01472